

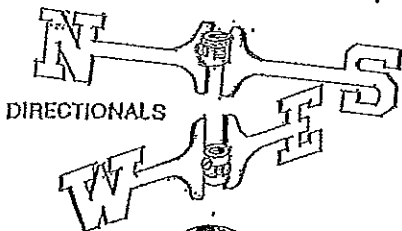



GOOD DIRECTIONS, INC. ASSEMBLY INSTRUCTIONS FULL SIZE WEATHERVANES

A2000

SMALL BALL 

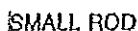

LARGE BALL 

SMALL ROD 

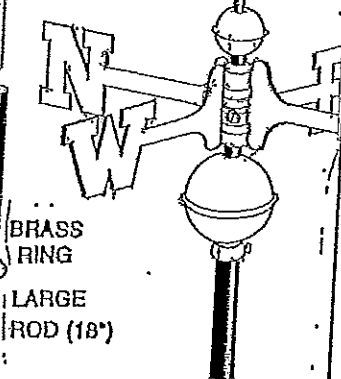

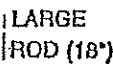
LARGE ROD (18") 

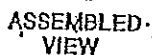
ASSEMBLED-VIEW 

YOUR PACKAGE INCLUDES THE FOLLOWING PIECES:

- 1 Figure
- 1 Small Ball
- 1 Large Ball
- 1 Set of Directionals
- 1 Brass Ring
- 1 Small Steel Threaded Rod
- 1 Large Steel Rod (18")

1

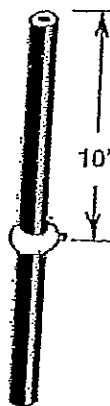

POSITION BRASS RING OVER LARGE ROD. TIGHTEN SET SCREW

2

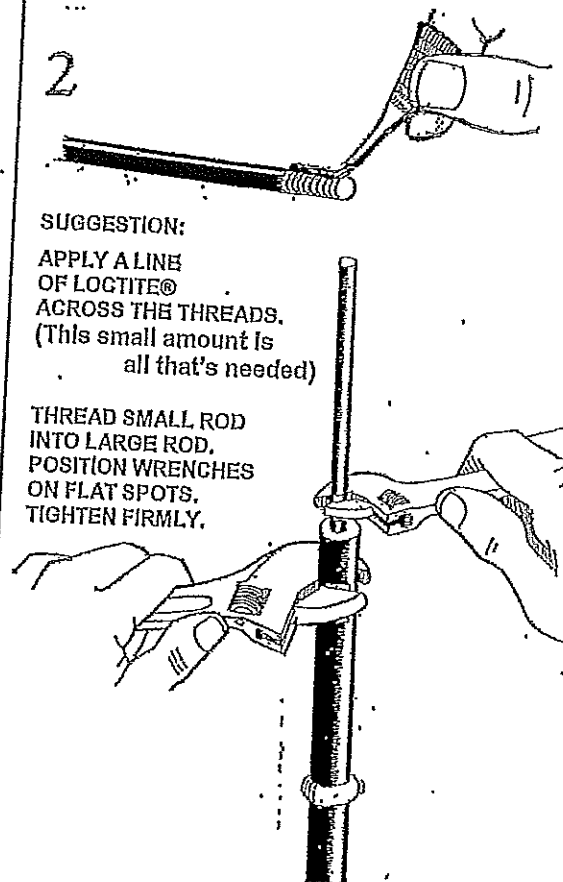

SUGGESTION:
APPLY A LINE OF LOCTITE® ACROSS THE THREADS. (This small amount is all that's needed)

THREAD SMALL ROD INTO LARGE ROD. POSITION WRENCHES ON FLAT SPOTS. TIGHTEN FIRMLY.

3

SLIDE LARGE BALL DOWN ROD TO BRASS RING.

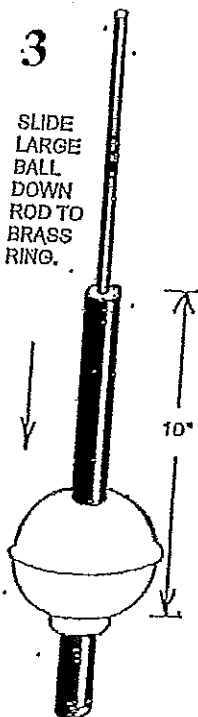

4

INTERLOCK DIRECTIONALS. SLIDE ONTO ROD. TIGHTEN SET SCREWS

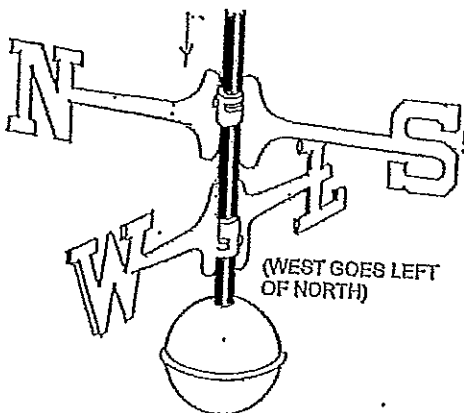

SLIDE TUBULAR BOTTOM OF WEATHERVANE OVER SMALL ROD.

5

APPLY COMMON GREASE TO ROD SO VANE WILL ROTATE FREELY.

FINAL STEP... SLIDE WEATHERVANE FIGURE ONTO SMALL ROD... ENJOY!

